

Article number: 20191B16B162BL

Description: E+G

T-angle clamps GN191-B16-B16-22-BL

Measures

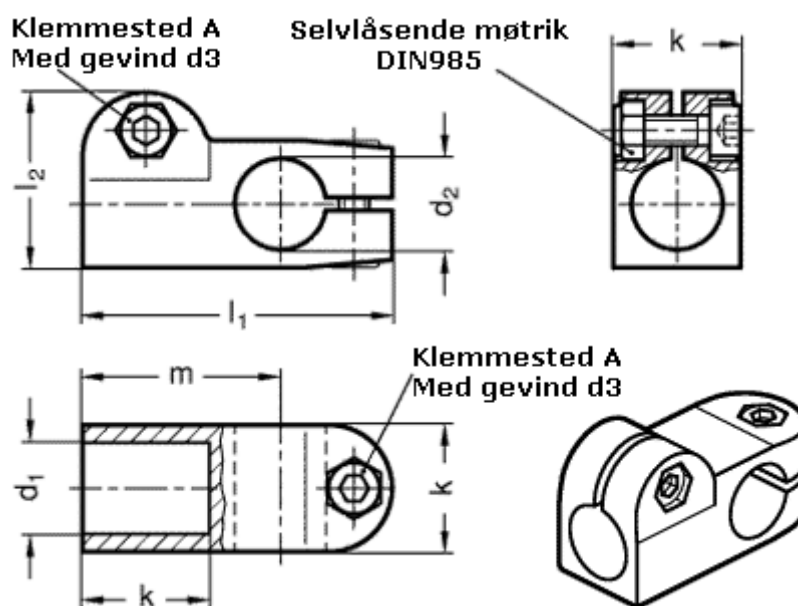

d1 = B16
d2 = B16
d3 = M 6
k = 25
l1 = 61
l2 = 34.5
m = 39